

SIRIUS HRI

High-pressure discharge lamps with reflector



Áreas de aplicación

- Architecture & Architainment

Beneficios del producto

- Lightweight and compact reflector lamps
- Perfectly suited for small and lightweight moving heads
- El diseño del quemador permite cualquier posición de quemado
- High luminance through very short arc and high pressure
- Luz brillante para efectos de luz
- Larga vida útil
- Easy lamp replacement
- Stable light output over the entire lifetime



Hoja de datos gama de productos

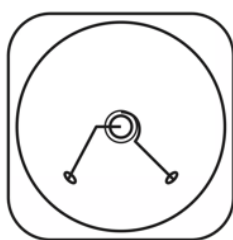
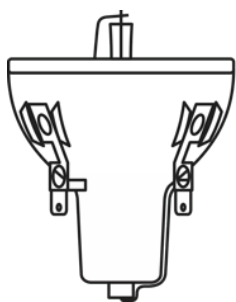

666507_SIRIUS HRI 100W

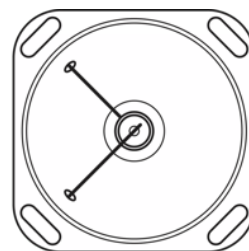
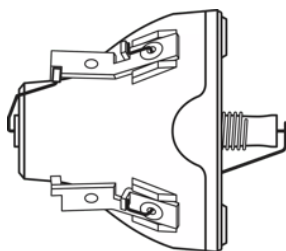

350611_SIRIUS HRI 132W

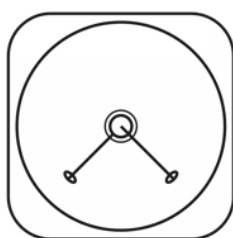
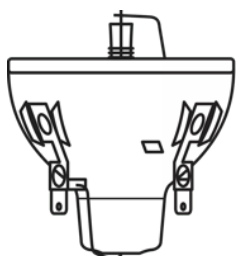

488735_SIRIUS HRI 132W

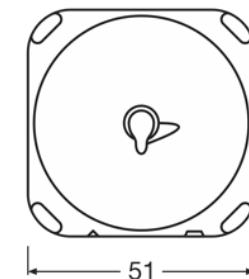
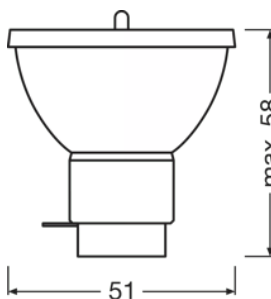

SIRIUS HRI 251W

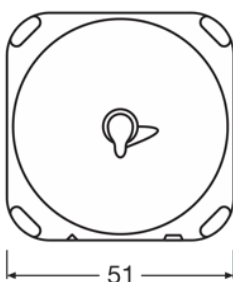
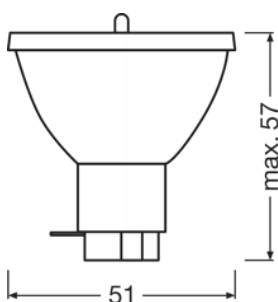

SIRIUS HRI 295 W

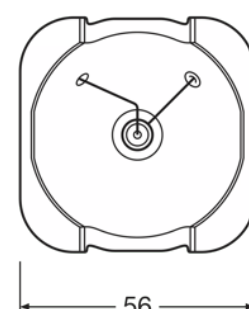
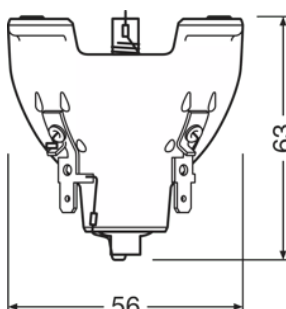

501950_SIRIUS HRI 330W

Hoja de datos gama de productos

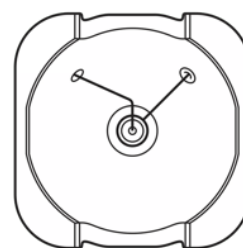
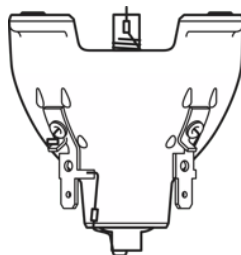
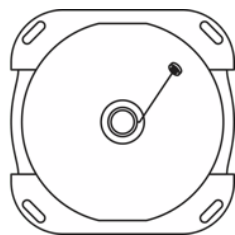
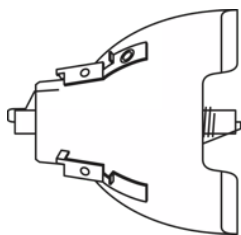

333382_SIRIUS HRI 330W

501965_SIRIUS HRI 330W

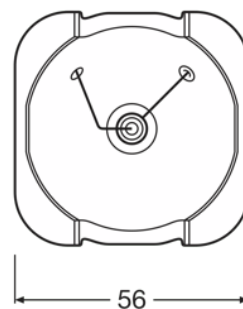
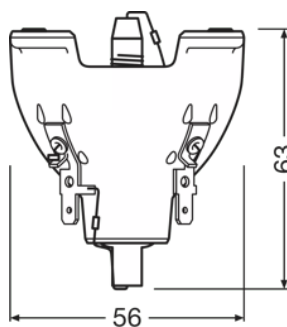
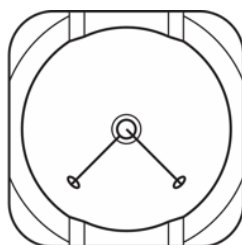
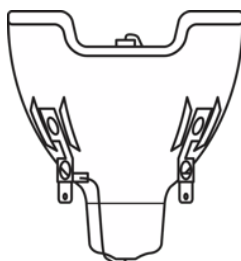

488771_SIRIUS HRI 330W X8

501949_Sirius HRI 330W XL

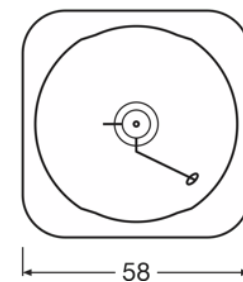
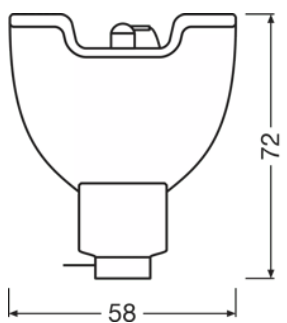
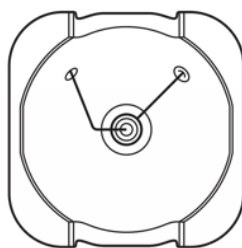
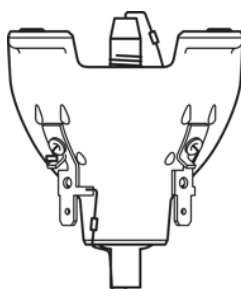

501963_Sirius HRI 330W XL

SIRIUS HRI 371W

Hoja de datos gama de productos

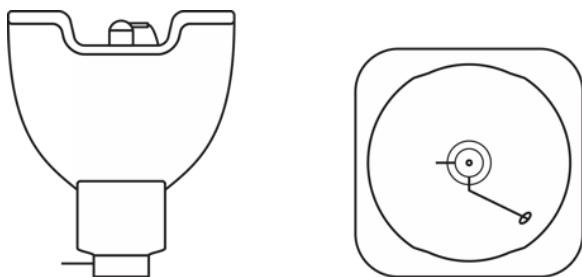

SIRIUS HRI 371W

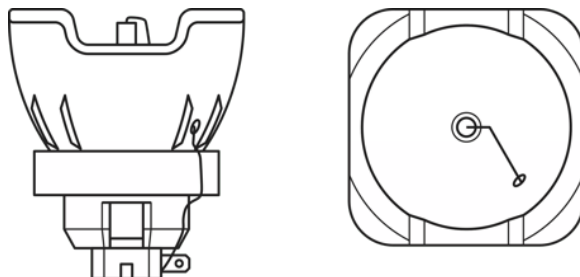

668858_SIRIUS HRI 440W

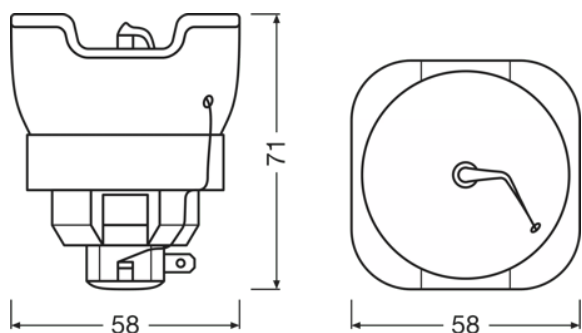

SIRIUS HRI 580 F

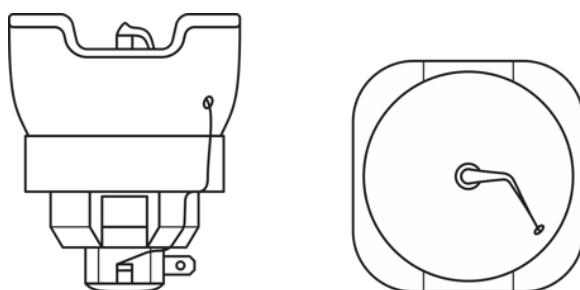

SIRIUS HRI 580 F

Hoja de datos gama de productos

Datos técnicos

Descripción del producto	Datos eléctricos		Datos Fotométricos				Datos técnicos de iluminación
	Potencia nominal	Corriente nominal	Flujo luminoso nominal	Temperatura de color	Índice de reproducción cromática Ra	Temperatura máxima de color	Longitud focal
SIRIUS HRI 100 W	100.00 W	1.8 A	3680 lm	9000 K	60	9300 K	30.0 mm
SIRIUS HRI 132 W SC	132.00 W	1.8 A	5150 lm	9200 K	60	9200 K	37.7 mm
SIRIUS HRI 140 W RO	140.00 W	1.9 A	5400 lm	9200 K	60	9200 K	37.7 mm
SIRIUS HRI 190 W+	190.00 W	2.2 A	8100 lm	8200 K	73	8200 K	34,5 mm
SIRIUS HRI 190 W+	190.00 W	2.7 A	8100 lm	8200 K	73		
SIRIUS HRI 230 W	230.00 W	3.3 A	9500 lm	8000 K	75	8000 K	34,5 mm
SIRIUS HRI 231 W	231.00 W	3.3 A	10800 lm	8000 K	75		
SIRIUS HRI 251 W	250.00 W	3.5 A	12000 lm	8000 K	77		
SIRIUS HRI 260 W PRO	260.00 W	3.7 A	13500 lm	7800 K	79		
SIRIUS HRI 280 W	280.00 W	4 A	11500 lm	7800 K	78	7800 K	35.5 mm
SIRIUS HRI 280 W RO	280.00 W	4 A	11500 lm	7800 K	78		
SIRIUS HRI 281 W	281.00 W	4 A	13000 lm	7800 K	78		
SIRIUS HRI 295 W	295.00 W	4.1 A	11300 lm	7800 K	78		
SIRIUS HRI 310 W	310.00 W	4.5 A	15000 lm	8000 K	84		
SIRIUS HRI 310 W RO	310.00 W	4.8 A	13000 lm	8500 K	78		
SIRIUS HRI 310 W PRO	310.00 W	5 A	15500 lm	7650 K	85		
SIRIUS HRI 311 W	310.00 W	3.3 A	14500 lm	8000 K	75		
SIRIUS HRI 330 W	330.00 W	5 A	18000 lm	7400 K	86	7400 K	31.0 mm
SIRIUS HRI 330 W X8	330.00 W	4.4 A	18000 lm	8000 K	85		
SIRIUS HRI 330 W XL	330.00 W	5 A	16500 lm	7250 K	71		
SIRIUS HRI 371 W	371.00 W	5 A	18300 lm	7650 K	85		
SIRIUS HRI 371 W S	371.00 W	5 A	19800 lm	7650 K	85		
SIRIUS HRI 371 W +	370.00 W	5 A	18300 lm	7650 K	85		
HRI 371 W S +	370.00 W	5 A	19800 lm	7650 K	85		
SIRIUS HRI 381 W S	380.00 W	5 A	20000 lm	7700 K	85		
SIRIUS HRI 380 W Pro	380.00 W	5 A	20000 lm	7700 K	85		
SIRIUS HRI 380 W S PRO	380.00 W	5 A	20000 lm	7700 K	85		
SIRIUS HRI 382 W	382.00 W	5.4 A	21000 lm	7650 K	85		
SIRIUS HRI 382 W S	380.00 W	5.4 A	20000 lm	7650 K	85		
SIRIUS HRI 420 W	420.00 W	5 A	22000 lm	7700 K	85		
SIRIUS HRI 420 W S	420.00 W	5 A	21000 lm	7700 K	85		
SIRIUS HRI 440 W	440.00 W	5.3 A	20000 lm	7000 K	80	7000 K	41.0 mm
SIRIUS HRI 440 W +	440.00 W	5.3 A	22800 lm	7000 K	80		
SIRIUS HRI 440 W H	440.00 W	5.3 A	18000 lm	7000 K	75		

Hoja de datos gama de productos

Descripción del producto	Datos eléctricos		Datos Fotométricos			Datos técnicos de iluminación	
	Potencia nominal	Corriente nominal	Flujo luminoso nominal	Temperatura de color	Índice de reproducción cromática Ra	Temperatura máxima de color	Longitud focal
SIRIUS HRI 440 W S	440.00 W	4.4 A	22800 lm	7000 K	80		
SIRIUS HRI 440 W X	440.00 W	5.3 A	22800 lm	7000 K	80		
SIRIUS HRI 461 W	461.00 W	5.3 A	24000 lm	7500 K	80		
SIRIUS HRI 461 W S	461.00 W	5.3 A	24000 lm	7500 K	80		
SIRIUS HRI 462 W	295.00 W	6.20 A	24000 lm	7900 K	85		
SIRIUS HRI 470 W	470.00 W	5.3 A	20500 lm	7000 K	80		
SIRIUS HRI 470 W S	470.00 W	5.3 A	21500 lm	7000 K	80		
SIRIUS HRI 470 W RO	470.00 W	5.3 A	19500 lm	7500 K	80		
SIRIUS HRI 470 W XL	470.00 W	5.3 A	24000 lm	7500 K	80		
SIRIUS HRI 471 W SN	471.00 W	5.3 A	20000 lm	7500 K	80		
SIRIUS HRI 550 W	550.00 W	6.1 A	28000 lm	7000 K	75		
SIRIUS HRI 550 W XL	550.00 W	6.1 A	28000 lm	7500 K	75		
HRI 580 W F	580.00 W	6.1 A	29500 lm	7000 K	75		

Descripción del producto	Abertura máxima ventana	Dimensiones y peso			Duración de vida
		Diámetro	Largo	Forma de la lámpara	Duración
SIRIUS HRI 100 W	5x3.8 mm	45.0 mm	53.0 mm	-	6000 h
SIRIUS HRI 132 W SC	5x3.8 mm	46.0 mm	max. 44 mm	-	6000 h
SIRIUS HRI 140 W RO	5x3.8 mm	46.0 mm	max. 44 mm	-	6000 h
SIRIUS HRI 190 W+	5x3.8 mm	51.0 mm	54.2 mm	-	3000 h
SIRIUS HRI 190 W+		51.0 mm	54.5 mm		3000 h
SIRIUS HRI 230 W	5x3.8 mm	51.0 mm	54.5 mm	-	2500 h
SIRIUS HRI 231 W		51.0 mm	50.0 mm		2000 h
SIRIUS HRI 251 W		51.0 mm	61.0 mm		3000 h
SIRIUS HRI 260 W PRO		51.0 mm	50.0 mm		6000 h
SIRIUS HRI 280 W	5x3.8 mm	51.0 mm	54.5 mm	-	2000 h
SIRIUS HRI 280 W RO		51.0 mm	54.5 mm		2000 h
SIRIUS HRI 281 W		51.0 mm	50.0 mm		2000 h
SIRIUS HRI 295 W		51.0 mm	53.5 mm		2500 h
SIRIUS HRI 310 W		51.0 mm	53.5 mm		2500 h
SIRIUS HRI 310 W RO		60.0 mm	67.0 mm		4000 h
SIRIUS HRI 310 W PRO		58.0 mm	72.0 mm		6000 h
SIRIUS HRI 311 W		51.0 mm	50.0 mm		1500 h
SIRIUS HRI 330 W	8.0 mm	56.0 mm	63.0 mm	-	1500 h
SIRIUS HRI 330 W X8		58.0 mm	66.0 mm		1500 h
SIRIUS HRI 330 W XL		56.0 mm	63.0 mm		1500 h

Hoja de datos gama de productos

Descripción del producto	Abertura máxima ventana	Dimensiones y peso			Duración de vida
		Diámetro	Largo	Forma de la lámpara	Duración
SIRIUS HRI 371 W		58.0 mm	72.0 mm		1500 h
SIRIUS HRI 371 W S		58.0 mm	72.0 mm		1500 h
SIRIUS HRI 371 W +		58.0 mm	72.0 mm		3000 h
HRI 371 W S +		58.0 mm	72.0 mm		3000 h
SIRIUS HRI 381 W S		58.0 mm	72.0 mm		2500 h
SIRIUS HRI 380 W Pro		58.0 mm	72.0 mm		2500 h
SIRIUS HRI 380 W S PRO		58.0 mm	72.0 mm		6000 h
SIRIUS HRI 382 W		58.0 mm	72.0 mm		2500 h
SIRIUS HRI 382 W S		58.0 mm	72.0 mm		2500 h
SIRIUS HRI 420 W		58.0 mm	72.0 mm		2500 h
SIRIUS HRI 420 W S		58.0 mm	72.0 mm		2500 h
SIRIUS HRI 440 W	8.0 mm	58.0 mm	71.0 mm	-	1500 h
SIRIUS HRI 440 W +		58.0 mm	71.0 mm		1500 h
SIRIUS HRI 440 W H		65.0 mm	60.0 mm		1500 h
SIRIUS HRI 440 W S		11.8 mm	71.0 mm		1500 h
SIRIUS HRI 440 W X		58.0 mm	71.0 mm		1500 h
SIRIUS HRI 461 W		60.0 mm	67.0 mm		1500 h
SIRIUS HRI 461 W S		60.0 mm	67.0 mm		1500 h
SIRIUS HRI 462 W		58.0 mm	72.0 mm		2000 h
SIRIUS HRI 470 W		58.0 mm	71.0 mm		1500 h
SIRIUS HRI 470 W S		58.0 mm	71.0 mm		1500 h
SIRIUS HRI 470 W RO		60.0 mm	67.0 mm		1500 h
SIRIUS HRI 470 W XL		60.0 mm	67.0 mm		1500 h
SIRIUS HRI 471 W SN		60.0 mm	67.0 mm		1500 h
SIRIUS HRI 550 W		60.0 mm	67.0 mm		1500 h
SIRIUS HRI 550 W XL		60.0 mm	67.0 mm		1500 h
HRI 580 W F		65.0 mm	65.0 mm		1000 h

Descripción del producto	Capacidades		Certificados & Normas	Environmental information according Art. 33 of EU Regulation (EC) 1907/2006 (REACH)
	Posición de quemado	Enfriamiento	EEI – Etiqueta energética	Date of Declaration
SIRIUS HRI 100 W	Universal	Refrigeración forzada	B	06-03-2024
SIRIUS HRI 132 W SC	Universal	Refrigeración forzada	A	06-03-2024
SIRIUS HRI 140 W RO	Universal	Refrigeración forzada	A	06-03-2024
SIRIUS HRI 190 W+	Universal	Refrigeración forzada	A	26-10-2023
SIRIUS HRI 190 W+				07-03-2024
SIRIUS HRI 230 W	Universal	Refrigeración forzada	A	05-03-2024
SIRIUS HRI 231 W	Universal		A	06-03-2024

Hoja de datos gama de productos

Descripción del producto	Capacidades		Certificados & Normas	Environmental information according Art. 33 of EU Regulation (EC) 1907/2006 (REACH)
	Posición de quemado	Enfriamiento	EEI – Etiqueta energética	Date of Declaration
SIRIUS HRI 251 W				07-03-2024
SIRIUS HRI 260 W PRO				07-03-2024
SIRIUS HRI 280 W	Universal	Refrigeración forzada	A	05-03-2024
SIRIUS HRI 280 W RO	Universal		A	06-03-2024
SIRIUS HRI 281 W	Universal		A	06-03-2024
SIRIUS HRI 295 W				26-10-2023
SIRIUS HRI 310 W				07-12-2023
SIRIUS HRI 310 W RO	Universal			07-12-2023
SIRIUS HRI 310 W PRO				07-03-2024
SIRIUS HRI 311 W				07-03-2024
SIRIUS HRI 330 W	Universal	Refrigeración forzada		05-03-2024
SIRIUS HRI 330 W X8	Universal		A	06-03-2024
SIRIUS HRI 330 W XL	Universal			06-03-2024
SIRIUS HRI 371 W	Universal			06-03-2024
SIRIUS HRI 371 W S	Universal			06-03-2024
SIRIUS HRI 371 W +				07-03-2024
HRI 371 W S +				15-03-2024
SIRIUS HRI 381 W S				22-12-2023
SIRIUS HRI 380 W Pro				07-03-2024
SIRIUS HRI 380 W S PRO				22-12-2023
SIRIUS HRI 382 W				07-12-2023
SIRIUS HRI 382 W S				07-12-2023
SIRIUS HRI 420 W				07-03-2024
SIRIUS HRI 420 W S				26-10-2023
SIRIUS HRI 440 W	Universal	Refrigeración forzada	A	06-03-2024
SIRIUS HRI 440 W +				22-12-2023
SIRIUS HRI 440 W H	Universal			06-03-2024
SIRIUS HRI 440 W S	Universal		A	06-03-2024
SIRIUS HRI 440 W X				07-03-2024
SIRIUS HRI 461 W	Universal			06-03-2024
SIRIUS HRI 461 W S	Universal			06-03-2024
SIRIUS HRI 462 W				26-10-2023
SIRIUS HRI 470 W	Universal			22-12-2023
SIRIUS HRI 470 W S	Universal			06-03-2024
SIRIUS HRI 470 W RO	Universal		A	17-05-2024
SIRIUS HRI 470 W XL	Universal			06-03-2024
SIRIUS HRI 471 W SN	Universal			06-03-2024
SIRIUS HRI 550 W				06-03-2024
SIRIUS HRI 550 W XL				27-10-2023

Hoja de datos gama de productos

	Capacidades		Certificados & Normas	Environmental information according Art. 33 of EU Regulation (EC) 1907/2006 (REACH)
Descripción del producto	Posición de quemado	Enfriamiento	EEI – Etiqueta energética	Date of Declaration
HRI 580 W F				22-12-2023

Descripción del producto	Primary Article Identifier	Candidate List Substance 1	Declaration No. in SCIP database
SIRIUS HRI 100 W	4052899321656 4052899329119	No declarable substances contained	No declarable substances contained
SIRIUS HRI 132 W SC	4052899011335 4052899028708 4052899197404	No declarable substances contained	In work
SIRIUS HRI 140 W RO	4052899224056 4052899258969	No declarable substances contained	In work
SIRIUS HRI 190 W+	4008321678201 4052899028739 4008321810281	No declarable substances contained	In work
SIRIUS HRI 190 W+	4008321866592 4052899475397	No declarable substances contained	In work
SIRIUS HRI 230 W	4008321678225 4008321810311	No declarable substances contained	In work
SIRIUS HRI 231 W	4052899512634 4052899553521 4062172041430 4062172128681 4062172212311	No declarable substances contained	In work
SIRIUS HRI 251 W	4062172212458 4062172212434	No declarable substances contained	No declarable substances contained
SIRIUS HRI 260 W PRO	4062172118941 4062172118927	No declarable substances contained	In work
SIRIUS HRI 280 W	4008321734303 4008321810342	No declarable substances contained	In work
SIRIUS HRI 280 W RO	4052899082151 4052899110397	No declarable substances contained	In work
SIRIUS HRI 281 W	4052899553552 4062172041454 4062172128704	No declarable substances contained	In work
SIRIUS HRI 295 W	4062172283328 4062172283304	No declarable substances contained	No declarable substances contained
SIRIUS HRI 310 W	4062172202169 4062172202183		In work
SIRIUS HRI 310 W RO	4062172013536 4062172063449 4062172140867 4062172140843	No declarable substances contained	In work

Hoja de datos gama de productos

Descripción del producto	Primary Article Identifier	Candidate List Substance 1	Declaration No. in SCIP database
SIRIUS HRI 310 W PRO	4062172085304 4062172169424 4062172169455	No declarable substances contained	In work
SIRIUS HRI 311 W	4062172169363		In work
SIRIUS HRI 330 W	4008321754448 4008321810373	No declarable substances contained	In work
SIRIUS HRI 330 W X8	4052899140295 4052899140325 4052899224346	No declarable substances contained	In work
SIRIUS HRI 330 W XL	4008321848765 4052899195431	No declarable substances contained	In work
SIRIUS HRI 371 W	4062172057004 4062172056984 4052899558649 4052899558670	No declarable substances contained	In work
SIRIUS HRI 371 W S	4062172056953 4062172056939 4052899558618	No declarable substances contained	In work
SIRIUS HRI 371 W +	4062172110341 4062172110327	No declarable substances contained	In work
HRI 371 W S +	4062172110396 4062172110372 4062172390729	No declarable substances contained	In work
SIRIUS HRI 381 W S	4062172226240 4062172226226	No declarable substances contained	In work
SIRIUS HRI 380 W Pro	4062172168625 4062172168601	No declarable substances contained	In work
SIRIUS HRI 380 W S PRO	4062172168335 4062172168311	No declarable substances contained	No declarable substances contained
SIRIUS HRI 382 W	4062172047135 4062172326131	No declarable substances contained	In work
SIRIUS HRI 382 W S	4062172033541 4062172326100	No declarable substances contained	No declarable substances contained
SIRIUS HRI 420 W	4062172192750 4062172192736	No declarable substances contained	In work
SIRIUS HRI 420 W S	4062172192705 4062172192682 4062172392938 4062172392891 4062172393225 4062172393201	No declarable substances contained	In work
SIRIUS HRI 440 W	4052899222212 4052899259096 4052899553644 4052899570566 4052899587892	No declarable substances contained	In work
SIRIUS HRI 440 W +	4062172047333 4062172348874	No declarable substances contained	No declarable substances contained
SIRIUS HRI 440 W H	4052899509528 4052899576735	No declarable substances contained	In work

Hoja de datos gama de productos

Descripción del producto	Primary Article Identifier	Candidate List Substance 1	Declaration No. in SCIP database
SIRIUS HRI 440 W S	4052899276543 4052899329140	No declarable substances contained	In work
SIRIUS HRI 440 W X	4062172017442	No declarable substances contained	No declarable substances contained
SIRIUS HRI 461 W	4052899532274 4052899553613	No declarable substances contained	No declarable substances contained
SIRIUS HRI 461 W S	4052899532298 4052899553583	No declarable substances contained	No declarable substances contained
SIRIUS HRI 462 W	4062172302128 4062172302104	No declarable substances contained	No declarable substances contained
SIRIUS HRI 470 W	4052899580961 4062172169332	No declarable substances contained	No declarable substances contained
SIRIUS HRI 470 W S	4052899580985 4062172169301	No declarable substances contained	In work
SIRIUS HRI 470 W RO	4052899476998 4052899477018 4062172392556	No declarable substances contained	In work
SIRIUS HRI 470 W XL	4052899581166 4062172017473 4062172168281	No declarable substances contained	In work
SIRIUS HRI 471 W SN	4052899581005 4062172040358	No declarable substances contained	In work
SIRIUS HRI 550 W	4062172008761 4062172078122	No declarable substances contained	In work
SIRIUS HRI 550 W XL	4062172008785 4062172168236 4062172168212	No declarable substances contained	In work
HRI 580 W F	4062172085267	No declarable substances contained	No declarable substances contained

Hoja de datos gama de productos

Instrucciones de seguridad

Debido a su elevada luminancia, la radiación UV y la elevada presión interna durante su funcionamiento, las lámparas SIRIUS HRI solo pueden funcionar en carcasas cerradas fabricadas especialmente para ese fin. Debe garantizarse con filtros adecuados que la radiación UV se vea reducida hasta un nivel aceptable. El mercurio se libera si se rompe la lámpara. Se requieren precauciones de seguridad especiales. Se dispone de información acerca de la seguridad y la manipulación a petición, o bien en el folleto que se adjunta con la lámpara, o en las instrucciones de funcionamiento.

Consejos de aplicación

Para más información detallada sobre la aplicación y gráficos vea la hoja de datos del producto.

Aviso

Sujeto a cambios sin aviso. Excepto errores y omisiones. Asegúrese de utilizar la emisión más reciente.